



miopack[®]

GROUP



mioplast[®]

FACTORY



**ALUMINIUM
PACKAGING**

**YOUR
IDEAL
CHOICE**

www.mioplast.com



For quality, cost and reliability, MIOPLAST is the packaging partner of choice.

Kalitesi, fiyat avantajı ve güvenilirliği ile çözüm ortağınız MIOPLAST.

MIOPLAST manufactures aluminium foil containers and catering disposables for the food industry throughout Europe and other international markets. We offers high quality food containers and takeaway foil containers for all markets in Food Sector. We are one of the largest food packaging company in TURKEY.

We have earned our reputation as a specialist manufacturer of aluminium foil containers. However, our product range incorporates a number of other items that are used in conjunction with the containers in food processing or food service applications.

Our portfolio of products now comprises:

- Conventional aluminium foil containers
- Foil Board Lids
- Aluminium foil Rolls
- Stretch (Cling) Film Rolls

ISO 9001:2015 Quality, ISO 22000:2005 Food Safety and BRC IOP Packaging Management Systems are used in MIOPLAST.

Mioplast firması genel olarak gıda endüstrisi için Avrupa ve diğer uluslararası pazarlara alüminyum folyo ve hazır yiyecek kapları üretmektedir. Bu ürünler yüksek kalite ve hijyen standartlarına uygun olarak üretilmekte olup, yurtiçi ve yurtdışı pazarlarda faaliyet gösteren son kullanıcı veya ithalatçı / distribütör firmalara ulaştırılmaktadır. Bu yüzden diyetimiz ki, Miopack Ambalaj, Türkiye'nin en büyük gıda ambalajı üreticisi firmalarından birisidir.

Mioplast sahip olduğu alüminyum folyo kap üretimi teknolojisi ile standart ürünlerin yanında, müşteri odaklı özel üretimlerde gerçekleştirilmektedir. Bu sayede gıda üretiminde ya da yiyecek servisinde ihtiyaç duyduğu ambalajı arayan firmalara avantaj sağlamaktadır.

Ürün portföyümüz:

- Alüminyum folyo kaplar
- Plastik, alüminyum ve lamineli karton kapaklar
- Alüminyum folyo rolleri
- Gıda ambalajları için streç filmler.



Aluminium containers protect perishable goods from all harmful environmental influences – even in the most extreme climates.

Aluminium containers are hygienic. Its surface cannot become a breeding ground for bacteria and other micro-organisms.

Aluminium is a totally inert material which doesn't allow any migration from or in to the product it has to protect. No odour, flavour or aroma can penetrate or escape.

Aluminium containers keep products fresh for a long time without quality deterioration.

Aluminium is not light, so this is an advantage which is equally beneficial for processors, salesman and shoppers.

Aluminium containers are handy, elegant and practical.

Aluminium containers are resistant because of their rigidity and will not become deformed during cooking.

Aluminium containers can readily be used in traditional ovens and in microwave ovens.

Aluminium is ecological because;

- Energy consumption has been reduce by 30 % during its production methods.
- Over 30 % of the worldwide production is made from recycled scrap.
- It saves energy.

Alüminyum kaplar çabuk bozulan gıdaları bütün çevresel ve mevsimsel etkilerin olumsuzluklarından korur.

Alüminyum kaplar hijyeniktir. Yüzeyinde bakteri ve diğer mikroorganizmaların üremesi için ortam oluşturmaz.

Tamamen inert (etkisiz) bir metal olan alüminyum içine konulan gıdalara ya da gıdalardan kendisine bir geçişe izin vermez. Bu yüzden gıdalarda herhangi bir koku, tat, renk kaybı ve değişikliği söz konusu değildir.

Alüminyum kaplar ürünleri uzun süre tadı ve lezzeti bozulmadan muhafaza eder.

Alüminyum hafif bir ürün olduğundan uygulayıcılar, satış elemanları ve dükkan sahipleri için avantajlı bir malzemedir.

Alüminyum kaplar kullanışlı, zarif ve pratiktir.

Alüminyum kaplar rijitlik özelliği nedeniyle pişirme işlemi sırasında deforme olmazlar.

Alüminyum kaplar geleneksel fırınlarda (gazlı, elektrikli) ve microdalga fırında kullanılabilir.

Alüminyum ekolojiktir çünkü;

- Üretim tekniği (soğuk şekil verme) nedeniyle proseste %30 daha az enerji tüketilir.
- Dünya alüminyum üretiminin en az %30'unda geri dönüşüm malzeme kullanılmaktadır.
- Isıyı muhafaza etme özelliği nedeniyle enerji tasarrufu sağlar.





BRC IOP



Quality, ISO 22000:2005



ISO 9001:2015

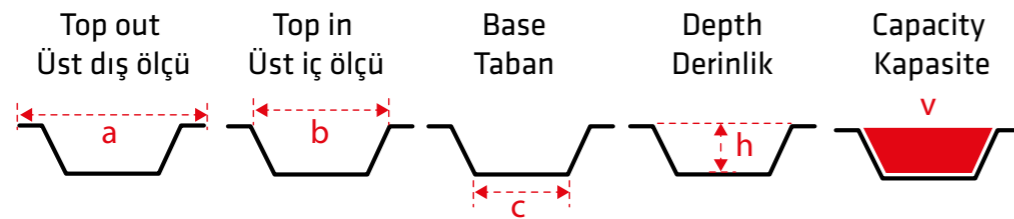

Aluminium foil and microwave ovens

Aluminium trays in the microwave oven: The right way to do it

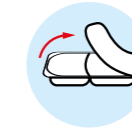
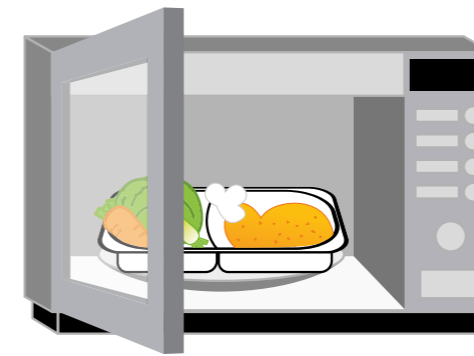

The aluminium lid must be removed from the tray before use.

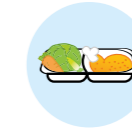

The meal should cover most of the floor of the tray.

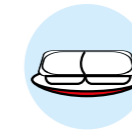

Place the aluminium tray in the middle of the turntable in the microwave oven. Attention if your microwave oven is equipped with a metal turntable, please place a ceramic or glass plate beneath to tray.

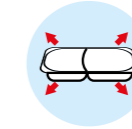

The aluminium dish must not come into contact with the walls of the microwave oven. (Minimum distance to the walls: 2 cm)

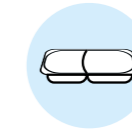

Only one aluminium tray may be used in the microwave oven at a time.

© 2007 by EAFA

The use of alufoil containers in microwave ovens is safe

Conclusive evidence that aluminium foil packaging can be used safely in microwave ovens has been established by a study from the Fraunhofer Institute for Process Engineering and Packaging IVW in Freising, Germany.

The results dispel the myth that aluminium foil containers are unsafe for use in microwave ovens and prove that consumer fears about using alufoil packs in the microwave are unfounded.

In fact in some instances consumer convenience is improved as not only are alufoil packs more rigid, something that is equally applicable to dual-ovenable containers, the use of aluminium foil enhances the appearance of the food when heated in the microwave oven. For example the study found that in the case of lasagne heated in a microwave oven its visual appearance was superior as a brown crust was formed on the surface.

Conducted on behalf of the European Aluminium Foil Association (EAFA) with the support of the Aluminium Foil Container Manufacturers Association (AFCMA) the study concluded, "Microwave heating of food packaged in aluminium foil trays or in plastic containers with aluminium foil or aluminium laminated lids is perfectly viable."

No hazardous results or damage to ovens were found in the more than 200 food portions that were heated in aluminium foil containers or packs containing aluminium foil.



ROUND / YUVARLAK

Aluminium / **Alüminyum**

Silver / **Gümüş**

Standard Single Layer Foil / **Standart Tek Kat Folyo**

It is suitable for use in the deep freezer. / **Derin dondurucuda kullanıma uygundur.**

Can be used up to +250 degrees / **+250 dereceye kadar kullanılabilir**

Catering, Home Meal, Bakery, Butcher, Other / **Şarküteri, Ev Yemekleri, Pastacılık, Et, Diğer**





M-602 L

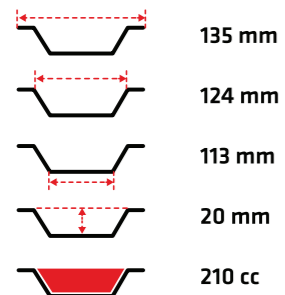

Matching Lid /
Eşleşen Kapak **M-602 LK CA**



M-804 LG

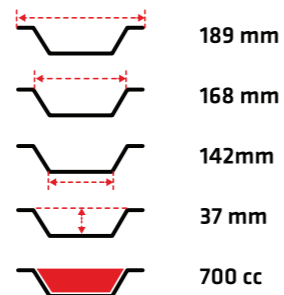

Matching Lid /
Eşleşen Kapak **M-804 LK CA**



M-802 LG

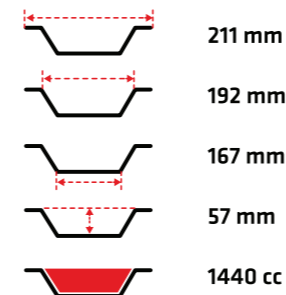

Matching Lid /
Eşleşen Kapak **M-802 LK CA**



M-804 L

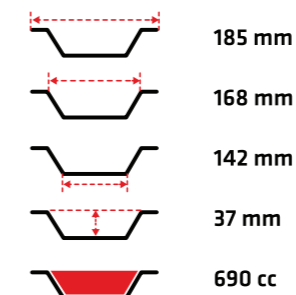

Matching Lid /
Eşleşen Kapak **M-804 LK CA**



M-807 LG

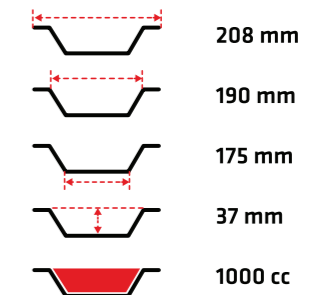

Matching Lid /
Eşleşen Kapak **M-807 LK CA**



M-803 L

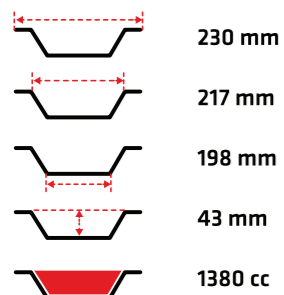

Matching Lid /
Eşleşen Kapak **M-803 LK CA**



M-175 G

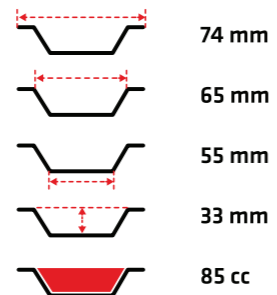

Matching Lid /
Eşleşen Kapak -



M-185 G

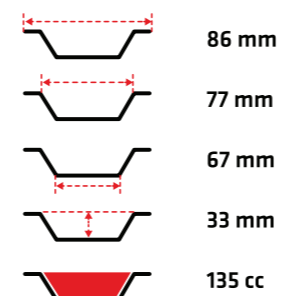

Matching Lid /
Eşleşen Kapak -



M-180 G

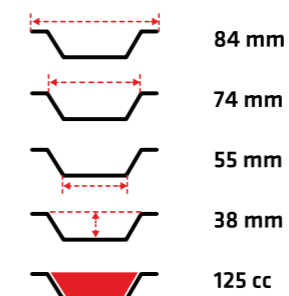

Matching Lid /
Eşleşen Kapak -



M-195 G

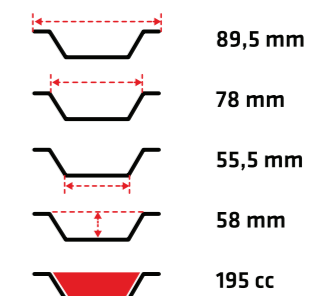

Matching Lid /
Eşleşen Kapak -



M-121 G

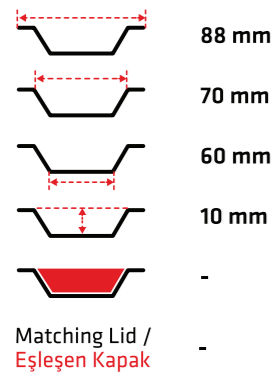

M-95 G

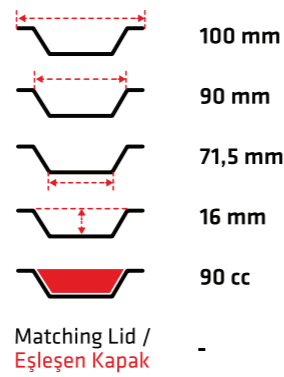

M-138 G

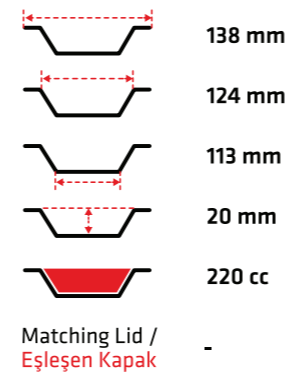

M-832 G

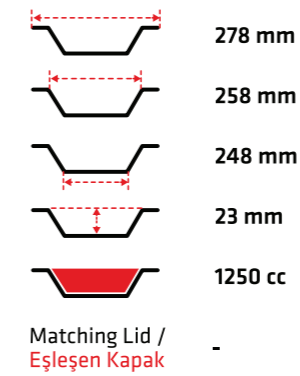

M-101 G

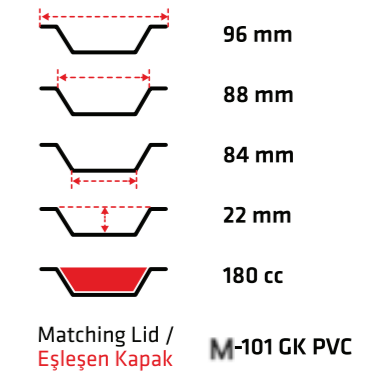

M-109 G

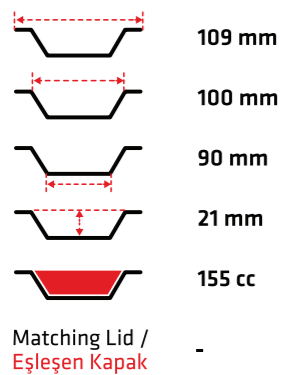

M-230 G

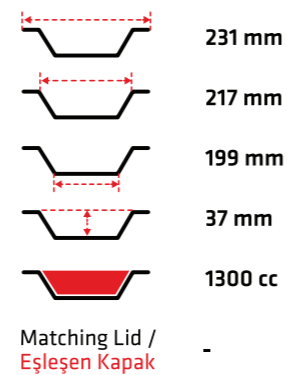

M-T247 G

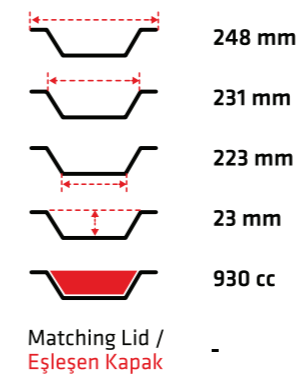

M-T285 G

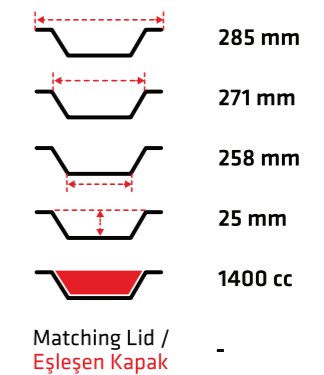



RECTANGULAR / DİKDÖRTGEN

Aluminium / Alüminyum

Silver / Gümüş

Standard Single Layer Foil / Standart Tek Kat Folyo

It is suitable for use in the deep freezer. / Derin dondurucuda kullanıma uygundur.

Can be used up to +250 degrees / +250 dereceye kadar kullanılabilir

Catering, Home Meal, Bakery, Butcher, Other / Şarküteri, Ev Yemekleri, Pastacılık, Et, Diğer





M-227 L

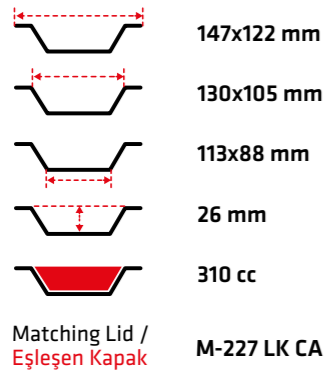

M-528 L

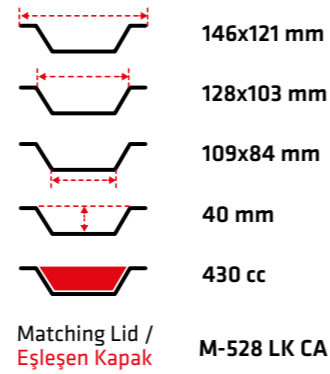

M-843 L

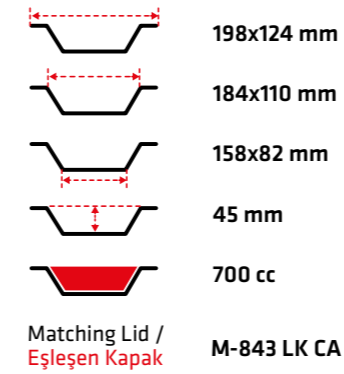

M-845 L

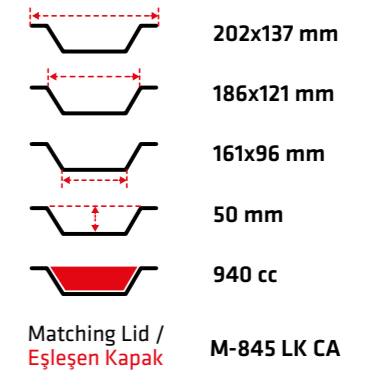

M-520 L/A

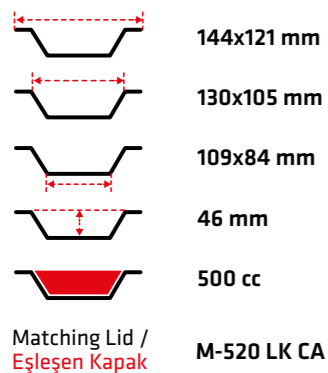

M - 325 L

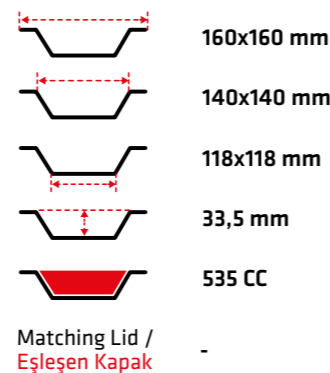

M-813 L

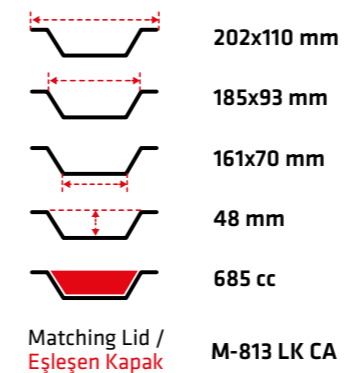

M-335 L

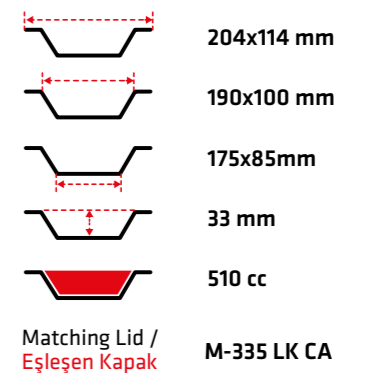



M-901 L

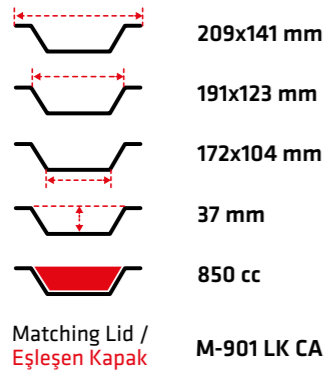

M-487 L

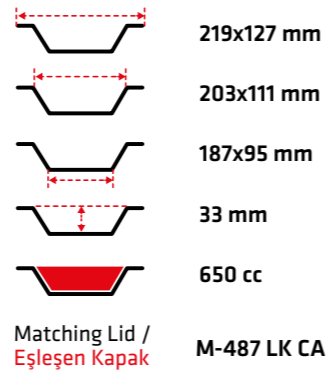

M-729 L

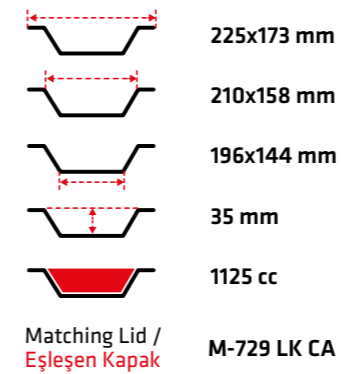

M-816 L

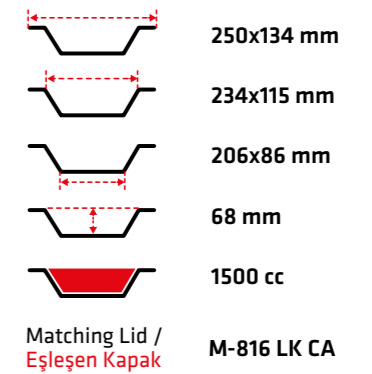

M-815 L

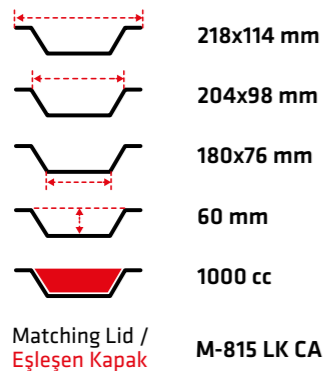

M-784 L

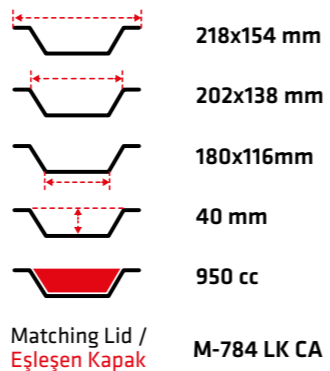

M-1250 L

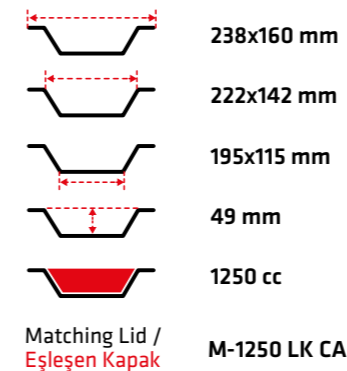

M-863 L

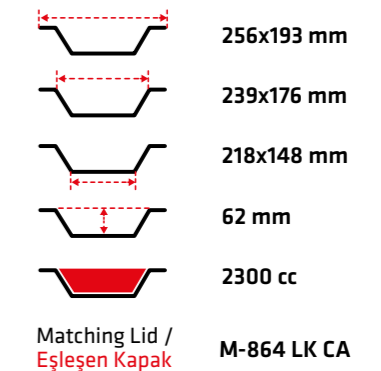



M-864 L

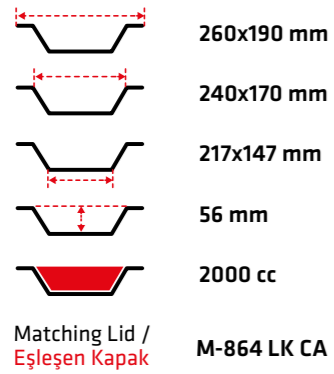

M-902 L

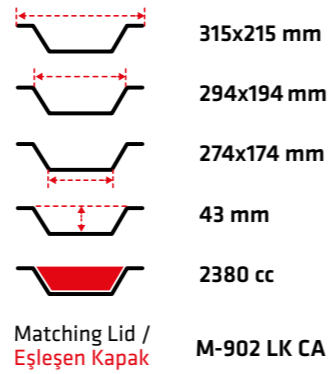

M-120 G

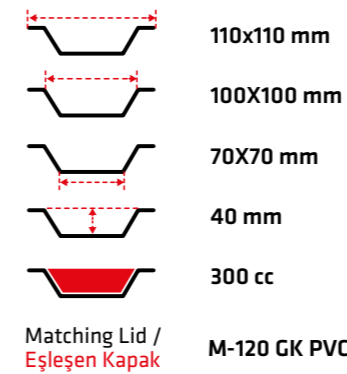

M-845 G

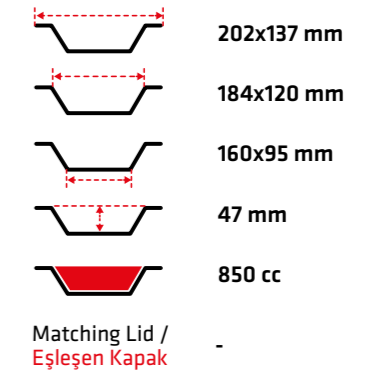

M-1500 L

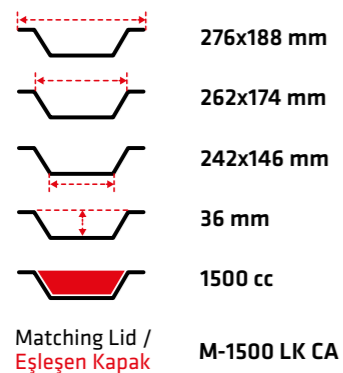

M-931 L

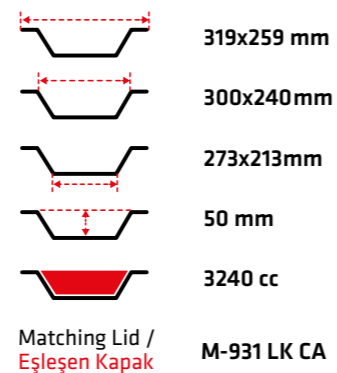

M-528 G

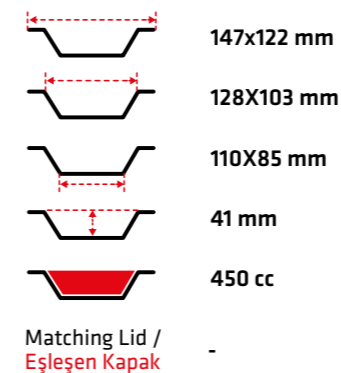

M-742 G

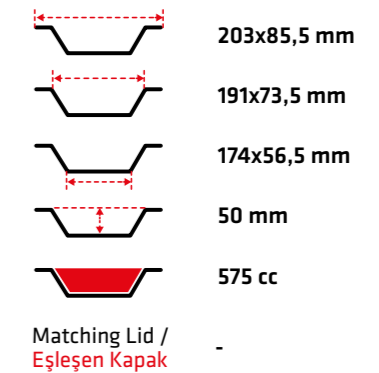



M-190 G

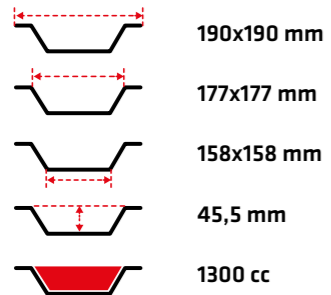

Matching Lid /
Eşleşen Kapak -



M-729 G

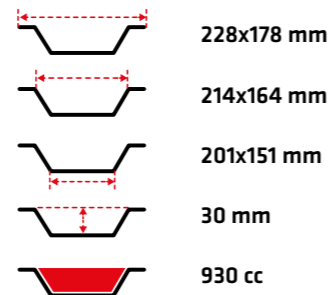

Matching Lid /
Eşleşen Kapak M-680-682-729 GH



M-715 G

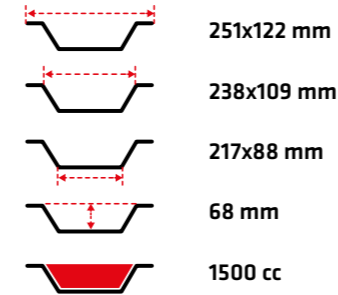

Matching Lid /
Eşleşen Kapak -



M-932 G

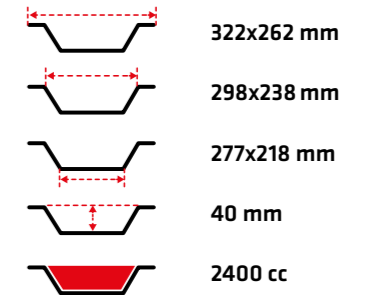

Matching Lid /
Eşleşen Kapak M-932-940 GH



M-760 G

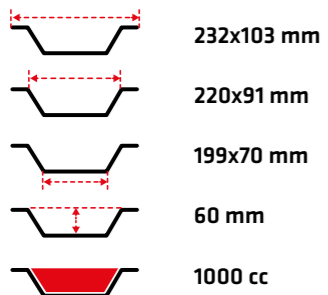

Matching Lid /
Eşleşen Kapak -



M-736 G

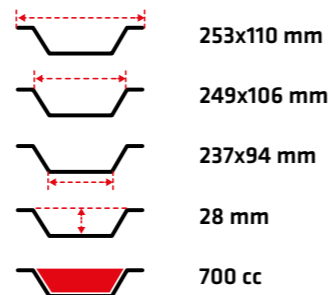

Matching Lid /
Eşleşen Kapak -



M-940 G

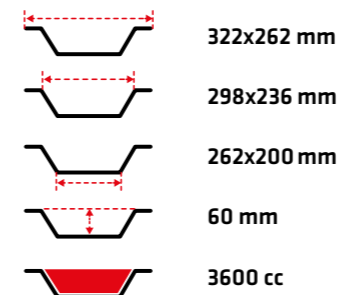

Matching Lid /
Eşleşen Kapak M-932-940 GH



M-922 G

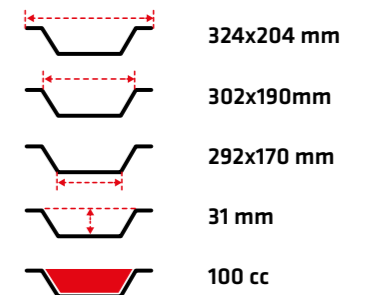

Matching Lid /
Eşleşen Kapak -



M-737 G

	325x105 mm
	316x96 mm
	302x82mm
	27,5 mm
	730 cc
Matching Lid / Eşleşen Kapak	-



M-954 G

	530x325 mm
	500x295 mm
	472x270 mm
	37 mm
	5400 cc
Matching Lid / Eşleşen Kapak	-



M-910 G

	398x338 mm
	368x308 mm
	343x283 mm
	50 mm
	4750 cc
Matching Lid / Eşleşen Kapak	-



M-985 G

	530x325 mm
	500x295mm
	456x251 mm
	80 mm
	9850 cc
Matching Lid / Eşleşen Kapak	M- 985 GH



SPECIAL SHAPES / ÖZEL ŞEKİLLER

Aluminium / Alüminyum

Silver / Gümüş

Standard Single Layer Foil / Standart Tek Kat Folyo

It is suitable for use in the deep freezer. / Derin dondurucuda kullanıma uygundur.

Can be used up to +250 degrees / +250 dereceye kadar kullanılabilir

Catering, Home Meal, Bakery, Butcher, Other / Şarküteri, Ev Yemekleri, Pastacılık, Et, Diğer





M-SW35 G

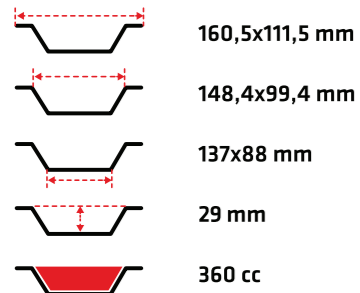

Matching Lid /
Eşleşen Kapak **M-SW35/50 GK**



M-SW50 G

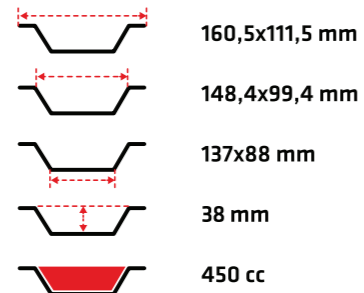

Matching Lid /
Eşleşen Kapak **M-SW35/50 GK**



M-SW22 G

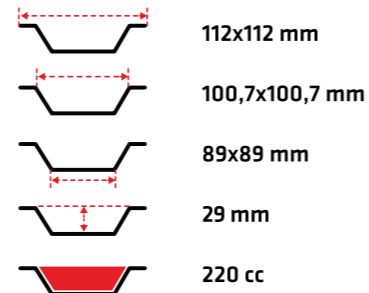

Matching Lid /
Eşleşen Kapak **M-SW22/33 GK**



M-SW33 G

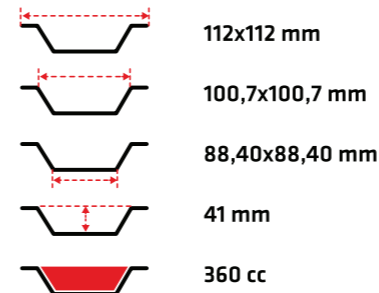

Matching Lid /
Eşleşen Kapak **M-SW33 GK**



M-SW10 G

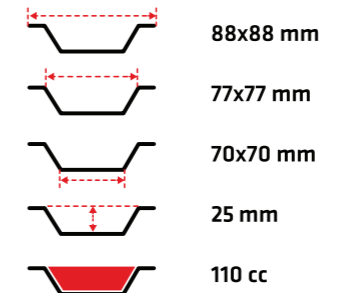

Matching Lid /
Eşleşen Kapak **M-SW10/15 GK**



M-SW15 G

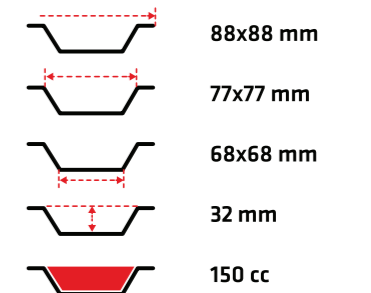

Matching Lid /
Eşleşen Kapak **M-SW10/15 GK**



M-100 G

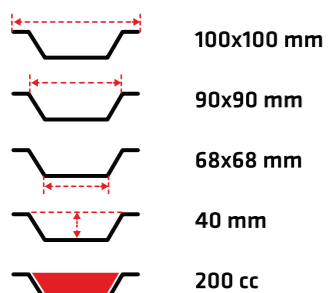

Matching Lid /
Eşleşen Kapak -



M-681 L

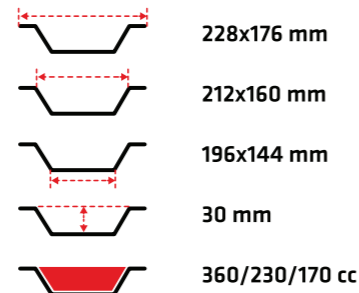

Matching Lid /
Eşleşen Kapak **M-681 LK CA**



M-680 L

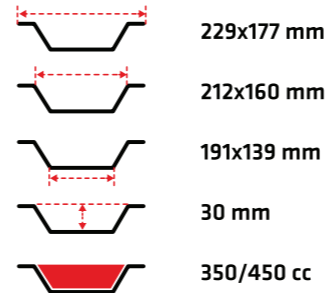

Matching Lid /
Eşleşen Kapak **M-680 LK CA**



M-AL25 G

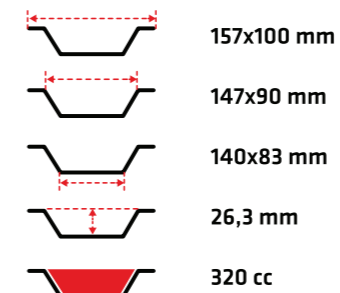

Matching Lid /
Eşleşen Kapak **M-AL 25 GK**



M-AL25 G-LACQ

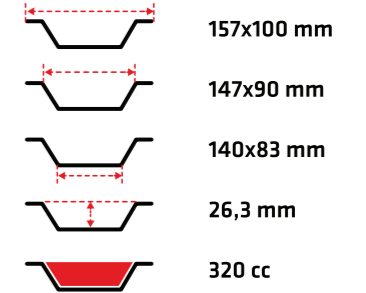

Matching Lid /
Eşleşen Kapak **M-AL 25 GK**



M-P 24 L

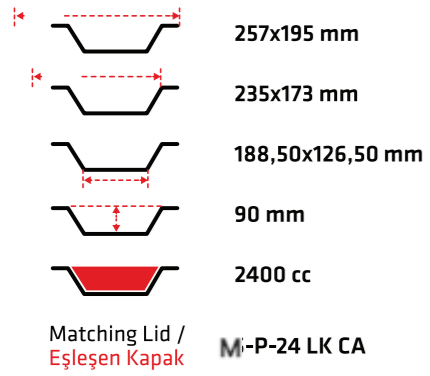

M-323 G-E

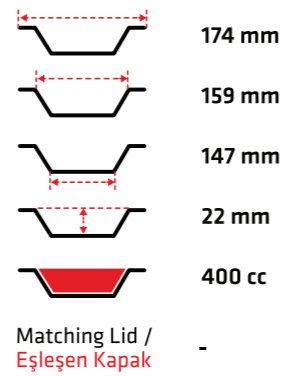

M-680 G

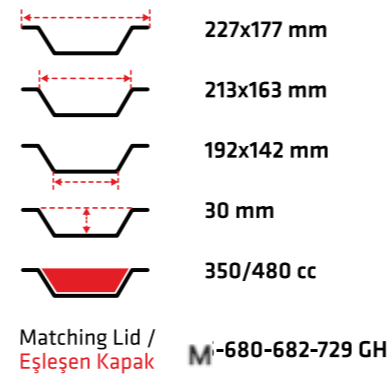

M-330 G

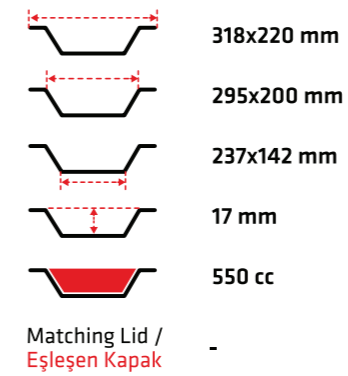

M-203 GR

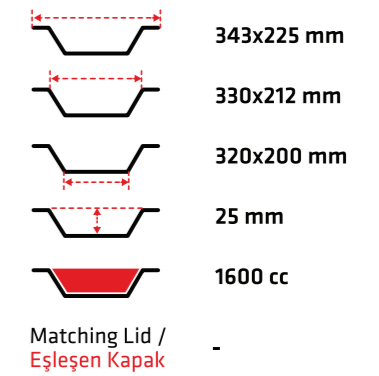

M-303 G/C

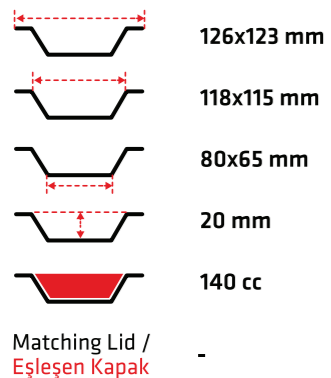

M-370 G-E

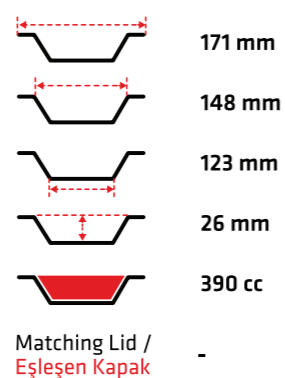

M-682 G

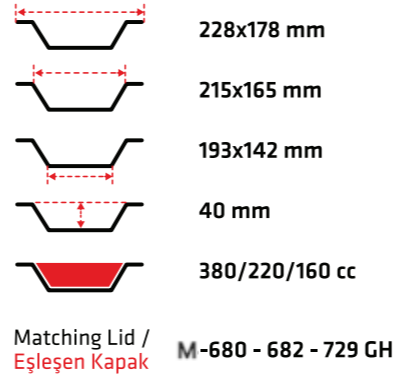

M-230 GD

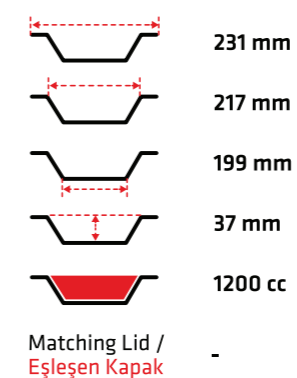

M-350 G

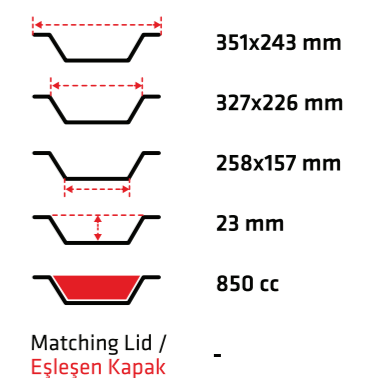



M-450 G

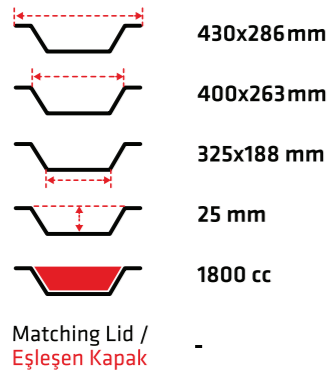

M-550 G

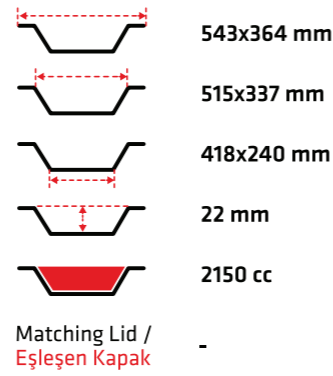

M-680-682-729 GH

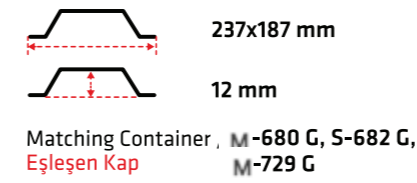

M-AL 25 GK

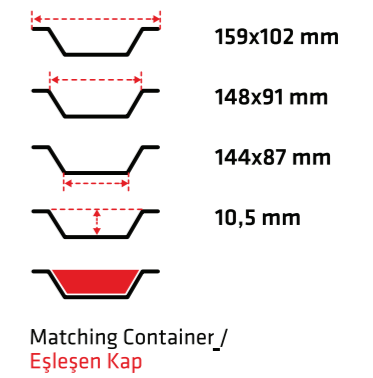

M-SW 33/22 GK

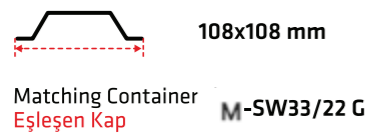

M-SW 35/50 GK

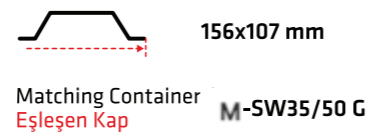

M-SW 10/15 GK

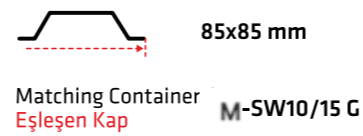

M-932-940 GH

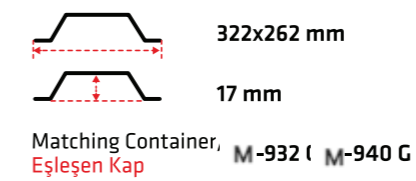

M-985 GH

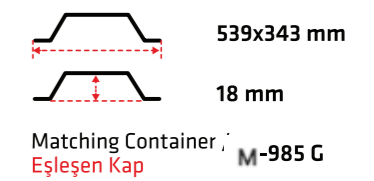

FOOD FOILS / GIDA FOLYOLARI

Aluminium / **Alüminyum**

Silver / **Gümüş**

Standard Single Layer Foil / **Standart Tek Kat Folyo**

It is suitable for use in the deep freezer. / **Derin dondurucuda kullanıma uygundur.**

Can be used up to +250 degrees / **+250 dereceye kadar kullanılabilir**

Catering, Home Meal, Bakery, Butcher, Other / **Şarküteri, Ev Yemekleri, Pastacılık, Et, Diğer**



MIO-300

ALU. ROLL FOIL. 300 mm

Sizes / Boyutlar	Length/mm
Width / Genişlik	300 mm
Length / Uzunluk	100 / 150 / 200 / 300 m
Thickness / Kalınlık	10-18 mic
Material / Malzeme	Aluminium / Alüminyum
Shape / Şekil	Roll / Rulo
Colour / Renk	Silver / Gümüş
Product category / Ürün kategorisi	Catering, Home Meal, Bakery, Butcher, Other Şarküteri, Ev Yemekleri, Pastacılık, Et, Diğer
Temperatures / Kullanım sıcaklığı	-200 °C to +350 °C
Foil / Folyo	Standard Single Layer / Standart Tek Kat

CORE SIZES / MASURA BOYUTLARI

Diameter / Çap	40 mm
Length / Uzunluk	325 / 335 mm
Material / Malzeme	Paper / Karton



MIO-450

ALU. ROLL FOIL. 450 mm

Sizes / Boyutlar	Length/mm
Width / Genişlik	450 mm
Length / Uzunluk	100 / 150 / 200 / 300 m
Thickness / Kalınlık	10-18 mic
Material / Malzeme	Aluminium / Alüminyum
Shape / Şekil	Roll / Rulo
Colour / Renk	Silver / Gümüş
Product category / Ürün kategorisi	Catering, Home Meal, Bakery, Butcher, Other Şarküteri, Ev Yemekleri, Pastacılık, Et, Diğer
Temperatures / Kullanım sıcaklığı	-200 °C to +350 °C
Foil / Folyo	Standard Single Layer / Standart Tek Kat

CORE SIZES / MASURA BOYUTLARI

Diameter / Çap	40 mm
Length / Uzunluk	475 / 485 mm
Material / Malzeme	Paper / Karton

FOOD STRETCHES / GIDA STREÇLERİ

Stretch / Streç

Silver / Gümüş

Standard Single Layer Foil / Standart Tek Kat Folyo

It is suitable for use in the deep freezer. / Derin dondurucuda kullanıma uygundur.

Can be used up to +250 degrees / +250 dereceye kadar kullanılabilir

Catering, Home Meal, Bakery, Butcher, Other / Şarküteri, Ev Yemekleri, Pastacılık, Et, Diğer



MSF-30

STRETCH FILM 300 mm

Film Sizes / Boyutlar	Length/mm
Width / Genişlik	300 mm
Length / Uzunluk	100,.....,300 m.
Thickness / Kalınlık	7 - 8 - 9 mic.
Shape / Şekil	Roll / Rulo
Film Colour / Renk	Pink, Champagne / Mor, Sarı
Product category / Ürün kategorisi	Catering, Home Meal, Bakery, Butcher, Other Şarküteri, Ev Yemekleri, Pastacılık, Et, Diğer
Temperatures / Kullanım sıcaklığı	-30 °C/+40 °C max. Optimum +15 °C/+25 °C
Film / Film	Standard Single Layer / Standart Tek Kat
Material / Malzeme	PVC
CORE SIZES / MASURA BOYUTLARI	
Diameter / Çap	40 mm
Length / Uzunluk	320 / 325 / 335 mm
Material / Malzeme	Paper / Karton



MSF-45

STRETCH FILM 450 mm

Film Sizes / Boyutlar	Length/mm
Width / Genişlik	450 mm
Length / Uzunluk	100,.....,300 m.
Thickness / Kalınlık	7 - 8 - 9 mic.
Shape / Şekil	Roll / Rulo
Film Colour / Renk	Pink, Champagne / Mor, Sarı
Product category / Ürün kategorisi	Catering, Home Meal, Bakery, Butcher, Other Şarküteri, Ev Yemekleri, Pastacılık, Et, Diğer
Temperatures / Kullanım sıcaklığı	-30 °C/+40 °C max. Optimum +15 °C/+25 °C
Film / Film	Standard Single Layer / Standart Tek Kat
Material / Malzeme	PVC
CORE SIZES / MASURA BOYUTLARI	
Diameter / Çap	40 mm
Length / Uzunluk	470 / 475 mm
Material / Malzeme	Paper / Karton



MMF-30/45

STRETCH MEAT FILM 300-400-450 mm

Film Sizes / Boyutlar	Length/mm
Width / Genişlik	300-400-450 mm
Length / Uzunluk	1000 -1500 m.
Thickness / Kalınlık	7 - 8 - 9 mic.
Shape / Şekil	Roll / Rulo
Film Colour / Renk	Champagne / Sarı
Product category / Ürün kategorisi	Catering, Home Meal, Bakery, Butcher, Other Şarküteri, Ev Yemekleri, Pastacılık, Et, Diğer
Temperatures / Kullanım sıcaklığı	-30 °C/+20 °C max. Optimum 0 °C/+10 °C
Film / Film	Standard Single Layer / Standart Tek Kat
Material / Malzeme	PVC
CORE SIZES / MASURA BOYUTLARI	
Diameter / Çap	76 mm
Length / Uzunluk	320-420-470 mm
Material / Malzeme	Paper / Karton



Sinanli offers a broad line of single and multi-compartment containers with either laminated cardboard or clear plastic dome lids that allow food to travel securely, retain temperature and are easy to seal, store and open.

M-802/807 LKT Transparent Round Dia.200mm.	M-803 LKT Transparent Round Dia.226mm.	M-804 LKT SHALLOW Transparent Round Dia.180mm.	M-804 LKT DEEP Transparent Round Dia.180mm.	M-101 GK PVC PVC Round Dia. 96 mm	M-120 GK PVC PVC Rect. 110X110 mm	M-729 LKT Transparent Rect. 220x170mm.
M-227 / 520 L A / 528 LK ALU. CARD. RECT. 140x115 mm	M-335 LK CA ALU. CARD. RECT. 201x109 mm	M-487 LK CA ALU. CARD. RECT. 213x122 mm	M-680/ 681/ 729 LK CA ALU. CARD. RECT. 220x168 mm	M-784 LK CA ALU. CARD. RECT. 211x150 mm		
M-813 LK CA ALU. CARD. RECT. 197x105 mm	M-815 LK CA ALU. CARD. RECT. 212x107 mm	M-816 LK CA ALU. CARD. RECT. 245x125 mm	M-843 LK CA ALU. CARD. RECT. 190x118 mm			
M-845 LK CA ALU. CARD. RECT. 195x130 mm	M-864 LK CA ALU. CARD. RECT. 254x185 mm	M-901 LK CA ALU. CARD. RECT. 206x136 mm	M-902 LK CA ALU. CARD. RECT. 307x207 mm			
M-1250 LK CA ALU. CARD. RECT. 232x153 mm	M-1500 LK CA ALU. CARD. RECT. 272x181 mm	M-931 LK CA ALU. CARD. RECT. 315x255 mm	M-P24 LK ALU. CARD. RECT. 250x187 mm			
M-602 LK CA ALU. CARD. ROUND DIA 132 mm	M-804 LK ALU. CARD. ROUND DIA 180 mm	M-807 LK ALU. CARD. ROUND DIA 200 mm	M-802 LK ALU. CARD. ROUND DIA 203 mm	M-803 LK ALU. CARD. ROUND DIA 225 mm		



Packing Method of Containers- International

CONTAINERS	Pieces / Bag	Pieces / Carton	Cartons / Pallet	Pieces / Pallet	Pallet Sizes (cm)	m3/Carton	Carton Sizes (mm) L x W x H
M-P24 L	50	500	24	12000	80 x 120	0,094	600 x 325 x 480
M-101 G	100	3000	20	60000	80 x 120	0,11	590 x 385 x 480
M-109 G	100	2000	48	96000	80x120	0,041	445 x 275 x 335
M-120 G	100	3000	20	60000	80 x 120	0,11	590 x 385 x 480
M-121 G	100	3000	42	126000	80x120	0,051	460 x 410x 270
M-175 G	100	1000	115	115000	80 x 120	0,016	260 x 158 x 383
M-185 G	100	1000	95	95000	80 x 120	0,020	183 x 248 x 442
M-203 GR	10	100	60	6000	80x120	0,031	355 x 250 x 350
M-227 L	100	1000	42	42000	80 x 120	0,051	460 x 410 x 270
M-230 G	100	600	20	12000	80 x 120	0,11	710 x 240 x 558
M-303 G/C	10	100	42	4200	80x120	0,051	460 x 410 x 270
M-330 G	10	100	60	6000	80x120	0,031	355 x 250 x 350
M-335 L	100	1000	26	26000	80 x 120	0,076	600 x 445 x 285
M-350 G	10	100	48	4800	80 x 120	0,0402	405 x 375 x 265
M-370 G	100	1000	26	26000	80x120	0,076	600 x 445 x 285
M-450 G	10	100	42	4200	80 x 120	0,056	460 x 410 x 300
M-487 L	100	1000	26	26000	80 x 120	0,076	600 x 445 x 285
M-520 L/A	100	1000	42	42000	80 x 120	0,051	460 x 410 x 270
M-528 G	100	1200	26	31200	80 x 120	0,076	600 x 445 x 285
M-528 L	100	1000	42	42000	80 x 120	0,051	460 x 410 x 270
M-550 G	50	50	32	1600	80 x 120	0,042	550 x 390 x 195
M-602 L	100	2000	20	40000	80 x 120	0,11	590 x 385 x 480
M-680 G	100	1000	20	20000	100 x 120	0,142	585 x 430 x 565
M-680 L	100	1000	20	20000	100 x 120	0,119	590 x 430 x 475
M-682 G	100	1000	20	20000	100 x 120	0,142	585 x 430 x 565
M-681 L	100	1000	20	20000	100 x 120	0,119	590 x 430 x 475
M-729 G	100	1000	20	20000	100 x 120	0,142	585 x 430 x 565
M-729 L	100	1000	20	20000	80 x 120	0,11	590 x 385 x 480
M-736 G	100	700	26	18200	80 x 120	0,076	600 x 400 x 315
M-742 G	100	1600	20	32000	80x120	0,11	590 x 385 x 480
M-760 G	100	1000	24	24000	80x120	0,094	600 x 325 x 480
M-784 L	100	1000	24	24000	80 x 120	0,094	600 x 325 x 480
M-802 LG	50	600	24	14400	80 x 120	0,094	600 x 325 x 480
M-803 L	50	400	24	9600	100 x 120	0,082	745 x 235 x 470
M-804 L	100	1000	20	20000	80 x 120	0,11	590 x 385 x 480

Packing Method of Containers- International

CONTAINERS	Pieces / Bag	Pieces / Carton	Cartons / Pallet	Pieces / Pallet	Pallet Sizes (cm)	m3/Carton	Carton Sizes (mm) L x W x H
M-804 LG	50	900	20	18000	80 x 120	0,11	590 x 385 x 480
M-807 LG	50	600	24	14400	80 x 120	0,094	600 x 325 x 480
M-813 L	100	1000	26	26000	80 x 120	0,076	600 x 445 x 285
M-815 L	100	1000	24	24000	80 x 120	0,094	600 x 325 x 480
M-816 L	100	1000	20	20000	80 x 120	0,11	590 x 385 x 480
M-832 G	50	500	24	12000	80 x 120	0,094	600 x 325 x 480
M-843 L	100	1000	24	24000	100 x 120	0,082	745 x 235 x 470
M-845 G	100	1000	24	24000	80 x 120	0,094	600 x 325 x 480
M-845 L	100	1000	24	24000	100 x 120	0,082	745 x 235 x 470
M-864 L	100	600	24	14400	80 x 120	0,094	600 x 325 x 480
M-901 L	100	1000	24	24000	80 x 120	0,082	745 x 235 x 470
M-902 L	50	500	20	10000	100 x 120	0,119	590 x 430 x 475
M-910 G	50	150	20	3000	80 x 120	0,079	552 x 347 x 415
M-922 G	100	600	20	12000	100x120	0,14	585x430x565
M-931 L	50	400	24	9600	80 x 120	0,094	600 x 325 x 480
M-932 G	100	100	48	4800	80 x 120	0,041	445 x 275 x 335
M-940 G	100	100	48	4800	80 x 120	0,041	445 x 275 x 335
M-954 G	100	100	20	2000	80 x 120	0,098	550 x 330 x 540
M-1250 L	100	1000	20	20000	100 x 120	0,119	590 x 430 x 475
M-1500 L	100	800	20	16000	100 x 120	0,119	590 x 430 x 475
M-285 G	100	400	20	8000	80x120	0,11	590x385x480
M-SW-33	100	900	32	28800	100x120	0,04	400x375x265
M-715 G	100	1000	20	20000	80x120	0,11	590x385x480
AI 25 G +GK	125	1000	24	24000	80x120	0,064	370x605x285
AI 25 G	125	1000	48	48000	80x120	0,041	445x275x335
M-190-G	100	1000	20	20000	100x120	0,142	585x430x565
M138-G	100	2000	20	40000	80x120	0,011	590x385x480
M-95-G	200	2000	42	84000	80x120	0,051	460x410x270
323 G/E	100	1000	26	26000	80x120	0,076	600x445x285
M-863-L	100	600	20	12000	80x120	0,094	600x325x480
M-SW100-G	100	2000	42	84000	80x120	0,057	460x410x300
M-737-G	100	500	28	14000	80x120	0,076	600x400x315
M-325-L	100	1000	36	36000	80x120	0,068	510x390x340
M-230-GD	100	600	20	12000	80x120	0,11	710x240x558

Packing Method of Containers- International

CONTAINERS	Pieces / Bag	Pieces / Carton	Cartons / Pallet	Pieces /Pallet	Pallet Sizes (cm)	m3/Carton	Carton Sizes (mm) L x W x H
M-180 G	100	3000	42	126000	80x120	0.051	460x 410 x 270
M-985 G	100	100	20	2000	80x120	0,107	550 x 330x 590
M-985 GH	100	100	36	2000	80x120	0,0486	552 x 352 x 250
M-SW 22 G	125	1125	32	36000	80x120	0,04	400 x 375 x 265
M-SW 35 G	100	900	42	37800	80x120	0,051	460 x 410x 270
M-SW 35 GK	500	6000	36	216000	100x120	0,0236	380 x 355 x 175
M-SW 50 G	100	900	42	37800	80x120	0,057	460 x 410 x 300
M-SW 10 G	150	2400	32	76800	80x120	0,04	400 x 375 x 265
M-SW 10 GK	850	17000	35	595000	100x120	0,0307	520 x 215 x 275
M-SW 33 GK/ M-SW 22 GK	600	7200	40	288000	100x120	0,0205	350x 260 x 225
M-T247 G	100	400	24	9600	80x120	0,074	560 x 245 x 540
M-195 G	50	3000	20	60000	80x120	0,11	590 x 385 x 480
M-SW 15 G	150	2400	32	76800	80x120	0,0402	405 x 375 x 265



Packing Method of Lids

LIDS	Pieces/Carton	Cartons Sizes (mm) L x W x H
M-101 GK PVC	1500	460 X 410 X 270
M-120 GK PVC	3000	550 X 440 X 410
M-729 LKT Transparent	1000	460 X 410 X 270
M-802/807 LKT Transparent	600	355 x 285 x 235
M-803 LKT Transparent	1000	460 X 410 X 270
M-804 LKT SHALLOW Transparent	900	460 X 410 X 270
M-804 LKT DEEP Transparent	900	460 X 410 X 300
M-227/520 L A /528 LK	1000	260 X 225 X 207
M-335 LK CA	1000	390 x 225 x 190
M-487 LK CA	1000	390 x 225 x 190
M-602 LK CA	2000	355 x 285 x 235
M-680 / 681 / 729 LK CA	1000	355 x 285 x 235
M-784 LK CA	1000	445 x 275 x 168
M-802 / 807 LK CA	600	445 x 275 x 168
M-803 LK	400	260 X 225 X 207
M-804 LK CA	900	355 x 285 x 235
M-813 LK CA	1000	390 x 225 x 190
M-815 LK CA	1000	390 x 225 x 190
M-816 LK CA	1000	445 x 275 x 168
M-843 LK CA	1000	390 x 225 x 190
M-845 LK CA	1000	445 x 275 x 168
M-864 LK CA	600	355 x 285 x 235
M-901 LK CA	1000	445 x 275 x 168
M-902 LK CA	500	355 x 285 x 235
M-931 LK CA	400	355 x 285 x 235
M-1250 LK CA	1000	445 x 275 x 168
M-1500 LK CA	800	355 x 285 x 235
M-P24 LK CA	500	445 x 275 x 168
M-680-682-729 GH	1000	395 X 375 X 265

Packing Method of Lids- International

LIDS	Pieces/Bag	Pieces/Carton	Cartons/ Pallet	Pieces/Pallet	Pallet Sizes (cm)	m3/Carton	Cartons Sizes (mm) L x W x H
M-101 GK PVC	-	1500	26	39000	80 x 120	0.051	460 X 410 X 270
M-120 GK PVC	-	3000	20	60000	80 x 120	0.099	550 X 440 X 410
M-729 LKT Transparent	100	1000	42	42000	80 x 120	0.051	460 X 410 X 270
M-802/807 LKT Transparent	100	600	60	36000	100 X 120	0.024	355 x 285 x 235
M-803 LKT Transparent	100	1000	42	42000	80 x 120	0.051	460 X 410 X 270
M-804 LKT SHALLOW Transparent	100	900	42	37800	80 x 120	0.051	460 X 410 X 270
M-804 LKT DEEP Transparent	100	900	42	37800	80 x 120	0.056	460 X 410 X 300
M-227/520 L A /528 LK	100	1000	120	120000	100 X 120	0.012	260 X 225 X 207
M-335 LK CA	100	1000	84	84000	100 X 120	0.017	390 x 225 x 190
M-487 LK CA	100	1000	84	84000	100 X 120	0.017	390 x 225 x 190
M-602 LK CA	100	2000	60	120000	100 X 120	0.024	355 x 285 x 235
M-680 / 681 / 729 LK CA	100	1000	60	60000	100 X 120	0.024	355 x 285 x 235
M-784 LK CA	100	1000	63	63000	100 X 120	0.021	445 x 275 x 168
M-802 / 807 LK CA	100	600	63	37800	100 X 120	0.021	445 x 275 x 168
M-803 LK	100	400	120	48000	100 X 120	0.012	260 X 225 X 207
M-804 LK CA	100	900	60	54000	100 X 120	0.024	355 x 285 x 235
M-813 LK CA	100	1000	84	84000	100 X 120	0.017	390 x 225 x 190
M-815 LK CA	100	1000	84	84000	100 X 120	0.017	390 x 225 x 190
M-816 LK CA	100	1000	63	63000	100 X 120	0.021	445 x 275 x 168
M-843 LK CA	100	1000	84	84000	100 X 120	0.017	390 x 225 x 190
M-845 LK CA	100	1000	63	63000	100 X 120	0.021	445 x 275 x 168
M-864 LK CA	100	600	60	36000	100 X 120	0.024	355 x 285 x 235
M-901 LK CA	100	1000	63	63000	100 X 120	0.021	445 x 275 x 168
M-902 LK CA	100	500	60	30000	100 X 120	0.024	355 x 285 x 235
M-931 LK CA	100	400	60	24000	100 X 120	0.024	355 x 285 x 235
M-1250 LK CA	100	1000	63	63000	100 X 120	0.021	445 x 275 x 168
M-1500 LK CA	100	800	60	48000	100 X 120	0.024	355 x 285 x 235
M-P24 LK CA	100	500	63	31500	100 X 120	0.021	445 x 275 x 168
M-680 GH	100	1000	48	48000	80 X 120	0.039	395 X 375 X 265

miopack®

mioplast®

MİOPACK AMBALAJ SANAYİ VE TİCARET LİMİTED ŞİRKETİ

İvedik Organized Industrial Zone, 1476 Cad. No: 8/14,
Yenimahalle, Ankara, Türkiye

Tel: +90 312 394 39 25 Mob: +90 535 275 56 66

Email: info@mioplast.com

